



*The Racking System Designed
By Installers for Installers*

PV Racking Ground System Installation Instructions



Key benefits:

- Easy installation. No clamps! No more straining to lean over and fasten bolts!
- Module installation time is far less than required by other systems.
- Module “Hold Down Area” is more than 10x that of conventional clamps.
- One of the strongest racking system on the market today. Rest assured, our rails will hold modules securely through the expansion/contraction changes due to seasonal temperature fluctuations.
- Module placement is seamless. No gaps between the modules results in a clean, sleek finish, without interruption.



*The Racking System Designed
By Installers for Installers*

PV Racking Ground System Installation Instructions

Table of Contents

The PV Racking Ground System.....	4
Components	4
Overview of installation	8
PV Racking Rail installation.....	8
Calculate the number of rails required and installation dimensions	8
Mounting the Rails to the Horizontal Beams	10
Installing Cross Bracing	11
Installing Horizontal Bracing (if required).....	11
Installing Seismic Bracing (if required).....	11
Installing the modules and end stops	13
Notes on Grounding the PV Racking System with DynoBond™:.....	14
Wire management with the PV Racking System.....	14
General Notes	15
Installation instruction updates	15
PV Racking 15 year Limited Warranty	16

This manual provides recommendations. Local and National codes govern the requirements for solar installation and must be followed.



*The Racking System Designed
By Installers for Installers*

Important: Please Read Before Starting

PV Racking components carry a 15 Year Limited Warranty. (See PV Racking 15 Year Limited Warranty for terms and conditions.) Installer shall install and operate all PV Racking components in accordance with the specifications and instructions from PV Racking and shall comply with all applicable rules, laws and regulations from local, state and federal governments and agencies, including the latest NEC Guidelines in connection with the installation of solar systems. FAILURE TO DO SO SHALL VOID ALL WARRANTIES FROM PV RACKING.

PLEASE REVIEW THIS MANUAL THOROUGHLY BEFORE INSTALLING YOUR PV RACKING SYSTEM.

Getting Started

This Installation Guide will provide you with the information needed for a professional installation. Please note the following items are the sole responsibility of the Installer and must be completed prior to installation:

PV RACKING'S BILL OF MATERIALS ORDER SHEET IS USED SOLELY FOR CREATING A BILL OF MATERIALS FOR A SOLAR ARRAY AND DOES NOT INCLUDE ANY ENGINEERING ANALYSIS. PV RACKING STRONGLY RECOMMENDS THAT ALL SOLAR INSTALLERS USE THE SERVICES OF THEIR OWN PROFESSIONAL ENGINEERS IN DESIGNING A SOLAR ARRAY TO ENSURE IT SATISFIES ALL SITE SPECIFIC STRUCTURAL REQUIREMENTS.

Comply with all applicable local, state or national building codes, including the current NEC Guidelines, and any that may supersede this manual.

Verify that correct and appropriate design parameters are used in determining the design loading used for design of the specific installation. Parameters, such as snow loading, wind speed, exposure and topographic factor should be confirmed with the local building official or a licensed professional engineer.

Verify that the roof structure is structurally sound and can support the array under all code level loading conditions that are appropriate. Verify that the ground structure supporting the array is structurally sound and can support the array under all code level loading conditions that are appropriate.

Only PV Racking parts used in conjunction with installer provided parts that are specified in the Installation Guide may be used. Substitution of other non- approved parts may void the Limited Warranty.

ALWAYS PROVIDE A WORK ENVIRONMENT THAT IS GEARED TOWARDS PERSONAL SAFETY!

This manual provides recommendations. Local and National codes govern the requirements for solar installation and must be followed.

The PV Racking Ground System

Conventions:

- North: toward the high side of the installation
- South: toward the low side of the installation
- East: toward the right side of the installation when facing north
- West: toward the left side of the installation when facing north
- Horizontal: east to west direction
- Vertical: north to south direction

Components

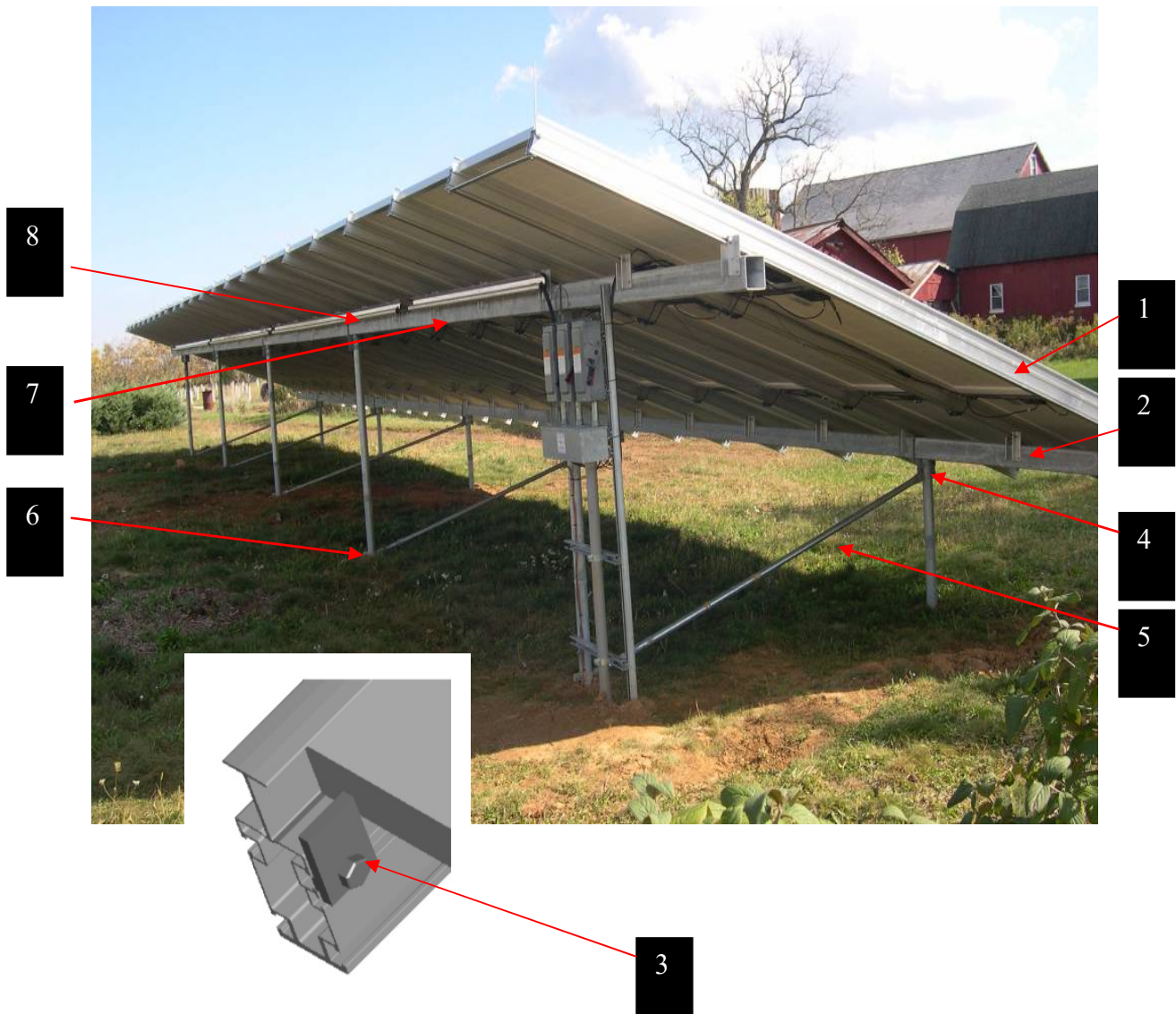

This manual provides recommendations. Local and National codes govern the requirements for solar installation and must be followed.

1 PV Racking Ground Rail, Gaaa (where aaa depends on the thickness of the module frame [see below])

Selecting Rails depends on the thickness of the module frame. There are five ranges available for modules. Please check the thickness of the module frame planned for the installation and select the proper Rail:

G135 Thickness of the module frame 1.16"-1.26" (29mm-32mm)
G153 Thickness of the module frame 1.30"-1.46" (33mm-37mm)
G178 Thickness of the module frame 1.49"-1.69" (38mm-43mm)
G194 Thickness of the module frame 1.73"-1.85" (44mm-47mm)
G213 Thickness of the module frame 1.89"-2.05" (48mm-52mm)

Rails available in 175", 202", and 240" lengths

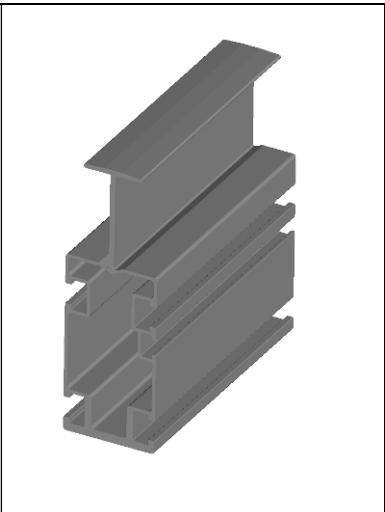

2 UGBrckt - Ground Rail Mounting Brackets

Ground rail brackets connect the Rails to the horizontal beams using self-tapping screws. PV Racking Rails can be connected to three types of horizontal beams; (2" and 3" diameter schedule 40 pipes and 5"x 4" rectangular hollow beams). **PV Racking offers all components to install with a 5" x 4" rectangular hollow beam, as seen below.**

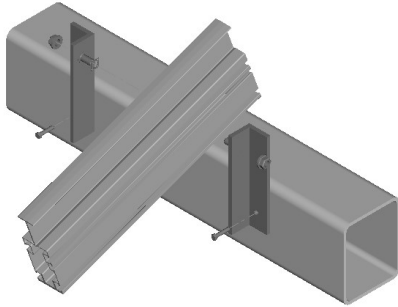
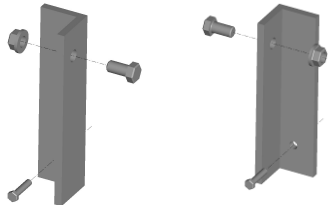

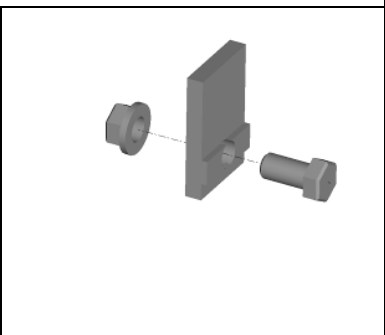

Each rail requires 4 brackets (2 at the north beam and 2 at the south beam).

3 GSTP - Module Stopper (each column of modules requires two stoppers)

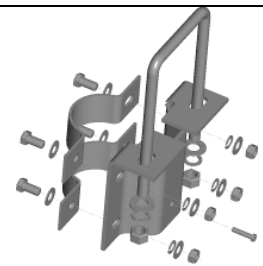
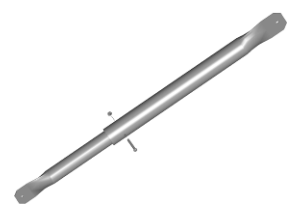
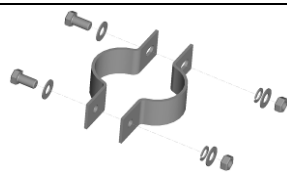
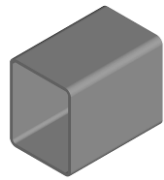

This manual provides recommendations. Local and National codes govern the requirements for solar installation and must be followed.

<p>4 FPC 2.5-5x4 - Post caps</p> <p>Post caps connect the vertical “legs” of the supporting structure to the horizontal beams.</p> <p>Post cap assembly 2.5” diameter leg to 5”x4” horizontal beam</p>	
<p>5 Cross Brace</p> <p>GCB – Standard Cross Brace (All Systems) Connects the top of the south “legs” to the bottom of the north “legs”.</p> <p>GHB – Horizontal Brace (System Specific) If required, connects to top of south legs Horizontally to the rear legs.</p> <p>GSB – Seismic Brace (System Specific) If required, connects to bottom of outer north leg and top of next north leg.</p>	
<p>6 GCBC2.5 - Cross Brace Connectors mounts to the bottom of the north “legs” and connects to the Cross Brace.</p> <p>2.5” Cross Brace Connector – Used to attach bracing when not connected to post caps.</p>	
<p>7 GHSSG-24 - Horizontal HSS Beam (Hollow Structured Steel Beam)</p> <p>5”x4” Galvanized steel beam Sold in quantities of 1.</p>	

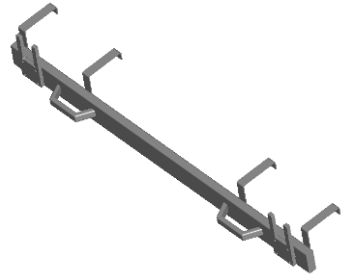
Optional accessories	
<p>Gspacer-A2 - 5” x 4” Column Spacing Fixture makes installation quicker and more precise</p> <p>Sold in quantities of 2.</p>	

This manual provides recommendations. Local and National codes govern the requirements for solar installation and must be followed.

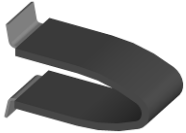
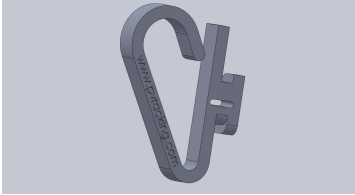
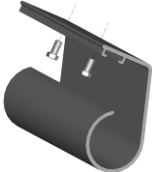
<p>Wire Clip</p> <p>Holds up to three wires securely to the Rails.</p> <p>WC-A300</p> <p>Sold in quantities of 300.</p>	
<p>Wire Loop</p> <p>Holds up to 8 wires securely to the rails</p> <p>WL-A300</p> <p>Sold in quantities of 300</p>	
<p>8 Wireway rail provides protection for home run wires (17.5' long)</p> <p>GWW - Includes Wireway rail, two plastic end caps, and 4 self-drilling screws</p>	

This manual provides recommendations. Local and National codes govern the requirements for solar installation and must be followed.



The Racking System Designed By Installers for Installers

Overview of installation

PV Racking provides unique installation unmatched in its adjustability, simplicity and quality. Superior module retention is provided without any clamps, lubricants, and other tasks associated with clamping modules in place. PV Racking's strength and non-clamped retention is a perfect match for installers wanting a fast and reliable solution to ground mount arrays.

Module installation is a quick three step process.

1. Install Ground Rail onto the frame.
2. Slide modules in place
3. Install Module Stoppers

This manual will review the steps that are required for successfully planning and installing a PV Racking Ground System. This manual will aid in deciding the number of rails required, installation techniques and grounding and wiring strategies.

General notes:

- Plan the layout of the modules on the support structure. Portrait orientation is favored as this provides the most support for the modules along their long edges.
- Make sure that the support structure can take the load. A structural engineer should investigate and approve the structure. The structure should be long enough to provide support for the first and the last Rail pieces.
- Follow the installation steps described in this manual.



PV Racking Rail installation

Calculate the number of rails required and installation dimensions

Calculate the number of rails required.

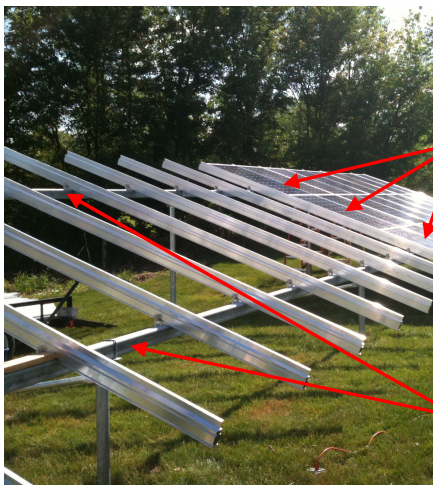

Step 1. Divide the total number of modules being installed by the number of modules in a column to get to the number of columns being installed (N_{oc}).

For example: 39 modules are installed in portrait format. There will be 3 modules per column. Calculate the number of columns as follows:

$$N_{oc} = 39 / 3 = 13 \text{ columns.}$$

There will be 13 columns.

Step 2. Calculate the number of rails (N_{or}) by adding 1 to the number of columns (N_{oc}).

Following the previous example:

$$N_{or} = N_{oc} + 1 = 13 + 1 = 14 \text{ rails.}$$

This manual provides recommendations. Local and National codes govern the requirements for solar installation and must be followed.



*The Racking System Designed
By Installers for Installers*

Calculate the length of the Horizontal Beam.

Calculate the length of the horizontal beam (L_{HB}) as follows:

(NOTE: Spans longer than 24 feet will either need to be welded or a “No-Weld Splice” will need to be used to extend the length of the array)

$$L_{HB} = N_{oc} * (\text{horizontal width of module} + 0.225") + 8"$$

For example: 39 modules are installed in portrait format. There will be 3 modules per column. $N_{oc}=13$. Module dimensions are 39.1" x 64.6".

$$\begin{aligned} \text{Minimum length of the horizontal beam} &= (N_{oc} \cdot (\text{horizontal width of module} + 0.225")) + 8" \\ &= (13 \cdot (39.1" + 0.225")) + 8" = \\ &= (13 \cdot 39.325) + 8" = \\ &= 511.225" + 8" = 519.25" \end{aligned}$$

Minimum length of the horizontal beam = 519.25" or about 43'-3"

The Horizontal Beam is mounted to the top of the front or rear support posts using the post cap assemblies (Fig. 4)

Calculate the center distance between rails.

Calculate the center distance between rails (CD) as follows:

$$CD = \text{horizontal dimension of the installed module} + 0.225"$$

For example: Module dimensions are 39.1" x 64.6". Modules are being installed in portrait.

$$CD = \text{horizontal dimension of the installed module} + 0.225"$$

$$CD = 39.1" + 0.225" = 39\text{-}21/64"$$

Using the GSpacer makes center dimension measurement obsolete. To use the templates set up the first two rails using tape measure and the above formula. Use these two rails to set up the templates. All additional rails can be quickly and precisely placed using the pair of templates without any further measuring.

Calculate the location of the Rail attachment points along the horizontal beam.

The exact position of the first Rail near the center of the horizontal beam depends on the number of columns (N_{oc}) calculated above. This is either an odd or an even number.

Case 1. Number of columns (N_{oc}) is even: There will be a Rail in the very center of the horizontal support beam.

Case 2. Number of columns (N_{oc}) is odd: The center of the first Rail piece is located on half of CD (calculated above) away from the center of the horizontal beam.

For example: $N_{oc}=13$. $CD = 39\text{-}21/64"$

Since $N_{oc}=13$ is an odd number, the center location for the first Rail is $CD/2$ ($19\text{-}5/8"$) away from the center of the horizontal beam. Locate the very center of the horizontal beam and measure $19\text{-}5/8"$ away from this point to locate the center of the first Rail.

Once the first rail is mounted the other rails are located CD away (measured center-to-center) from this and other rails.

This manual provides recommendations. Local and National codes govern the requirements for solar installation and must be followed.

Fig. 4

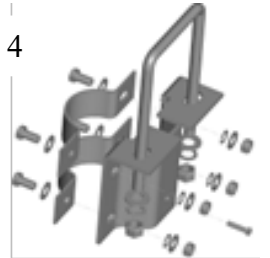

Mounting the Rails to the Horizontal Beams

Please note that the Rails must be installed such that the front and rear overhang dimensions are the same.

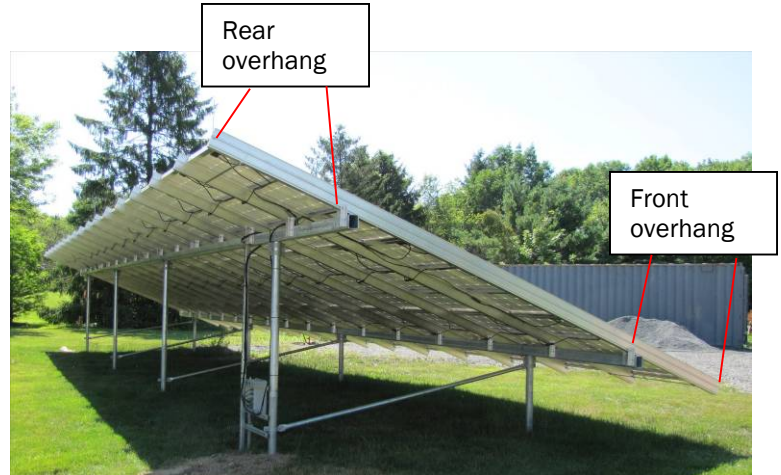

Mounting the Rail to the 5" x 4" structural Horizontal Beam.

Connect to the 5" x 4" rectangular beams using self-drilling screws (UGBrckt)

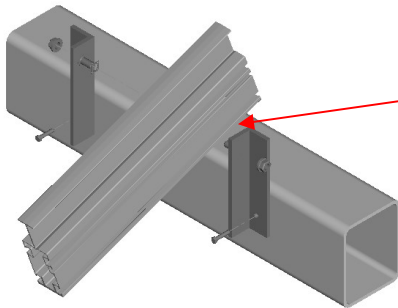

Use WEEB washer to ground rail to bracket. One WEEB washer needed on single north bracket, one WEEB washer needed on single south bracket (for each rail). You should use two WEEB washers per rail.

Procedure for using the UGBrckt brackets with self-drilling screws is as follows:

Step 1. Slide a 3/8 bolt head down the bottom T-slot on one side of the Rail. Make sure to use WEEB washer at connection point between rail and GBrcckt. This will ground rails to HSS (along with self-drilling screw). **One WEEB washer needed to each HSS beam.**

Step 2. Install the bracket onto the bolt and hand-tighten the nut.

Step 3. Hold the bracket flat against the horizontal beam and mark the hole location for the self-tapper.

Step 4. Drill a pilot hole through the horizontal beam with a 7/32 drill at the mark.

Step 5. Install the self-drilling screw through the bracket and the hole in the cross beam. Tighten it to 5.5 ft-lbs. maximum.

Step 6. Tighten the 3/8 bolt to 15 ft-lbs. maximum.

Step 7. Repeat the above steps to install the second bracket on the other side of the Rail.

Step 8. Repeat the above steps to install the other brackets at the other Horizontal Beam of the same rail.
(Continued next page)

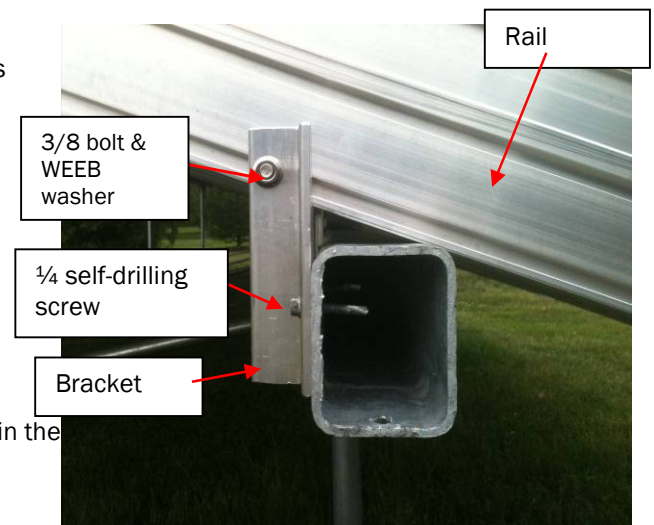

This manual provides recommendations. Local and National codes govern the requirements for solar installation and must be followed.

Install the next Rail at the calculated Center Distance (CD) away from the first one. Slide a module into the Rails to check the spacing. Make two spacers to tightly fit between the installed Rails. (Cut up an extra Rail for this purpose. Alternatively, use the Column Spacing Fixtures if the horizontal beam is 5" x 4".) These spacers would speed up the installation.

Installing Cross Bracing

Each cross bracing of the system is installed at the lowest point of the rear (North) legs of the frame using 1 cross brace connector (Fig. 6). The brace is then attached to the post cap of front (South) legs. Each set of legs (North and South) receives a cross brace.

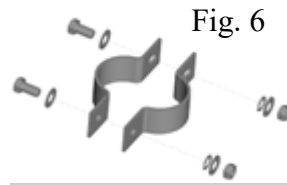

Installing Horizontal Bracing (if required)

Horizontal bracing may be required based on soil conditions, system height, system weight, or calculated wind and snow loads. Should such bracing be required, they should be installed as follows:

1. Install at lowest point of the rear (North) legs of the frame sharing the cross-brace connector (Fig. 6) with the cross brace for that leg pairing.
2. Install cross-brace connector (Fig. 6) to lowest point of front (South) leg and attach horizontal brace to this connector and tighten.

Installing Seismic Bracing (if required)

Seismic bracing may be required based on soil conditions, system height, system weight, or calculated wind and snow loads. Should such bracing be required, they should be installed as follows:

1. Seismic braces are attached to rear legs of the system at the two outermost sections of the array.
2. Install a cross-brace connector (Fig. 6) at highest point of the outermost rear (North) leg just below post cap and lowest point of the next rear (North) leg in from the end of the system.
3. Connect seismic brace to cross-brace connectors and tighten.

Bracing Illustration

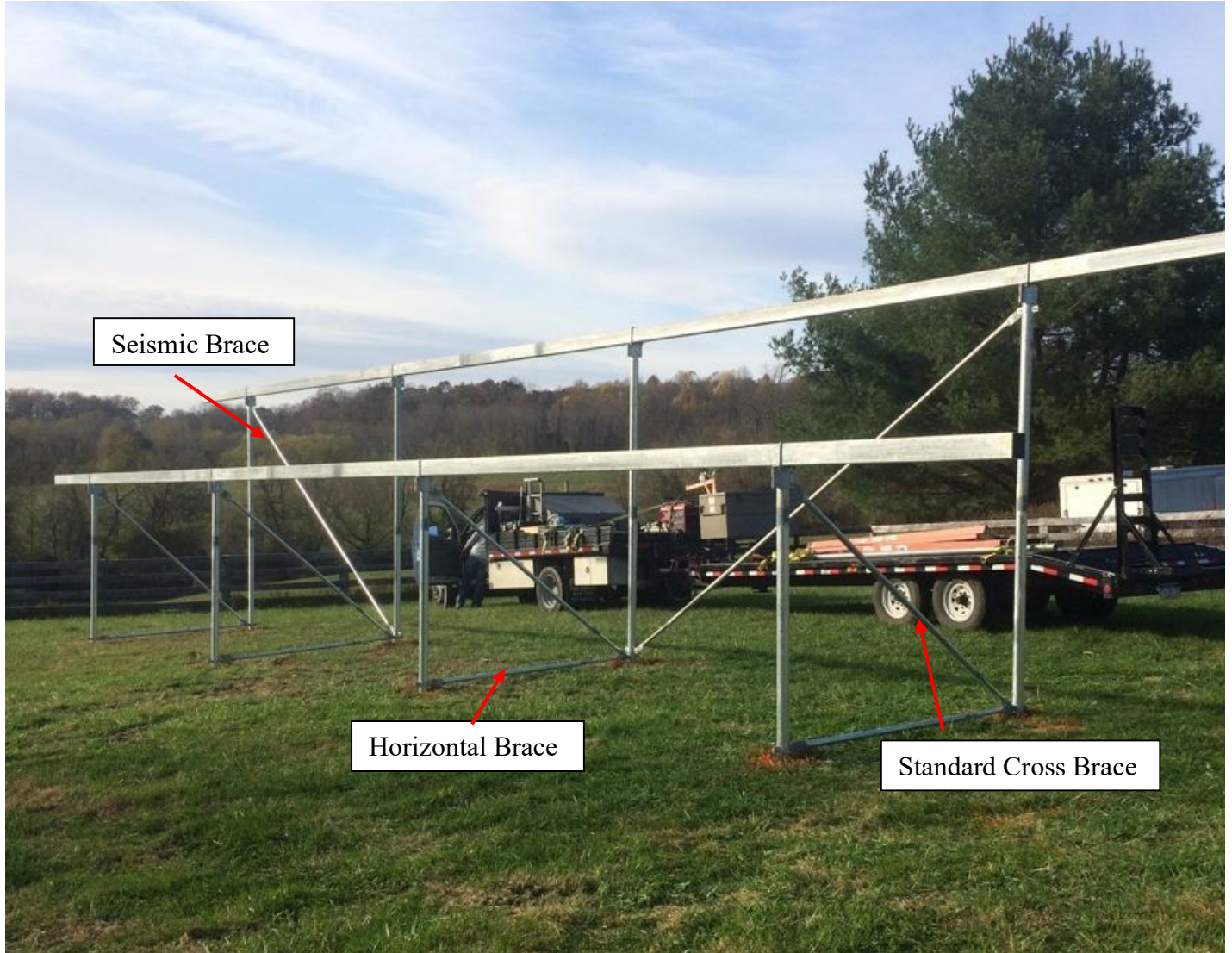

This manual provides recommendations. Local and National codes govern the requirements for solar installation and must be followed.

Installing the modules and end stops

Install the modules by sliding them into the Rails. Fasten a module stopper at the bottom of each Rail.

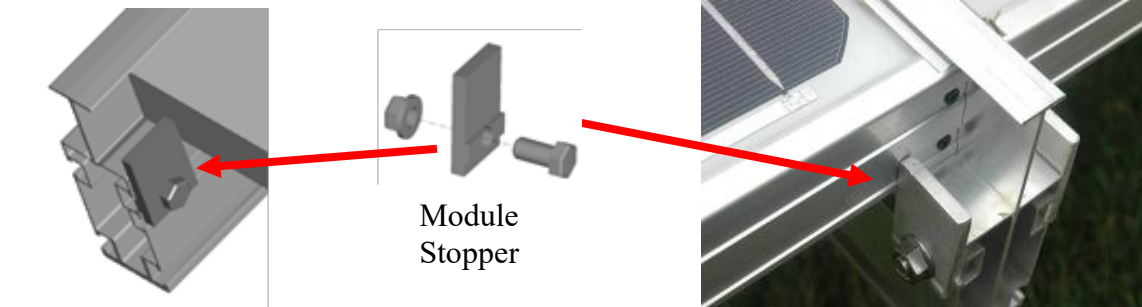

This manual provides recommendations. Local and National codes govern the requirements for solar installation and must be followed.



*The Racking System Designed
By Installers for Installers*

Notes on Grounding the PV Racking System with DynoBond™:

The DynoBond™ replaces the conventional method of installing one ground lug per solar module and running a solid six-gauge copper wire bonding the modules. The DynoBond™ is a proprietary, UL recognized design that allows the DynoBond™ to be used as a jumper between modules and rails; making the module frames the medium for the equipment ground path.

To ground module to module, slide stainless steel spring clip onto module frame. Connect adjacent panel frame with free end of the DynoBond™. To ground modules to rail, ground top module in column to the top of the PV Racking rail by bending tin-plated copper wire of DynoBond™ as needed. One stainless steel clip will connect to module frame, the other to the PV Racking rail. ** see PV Racking DynoBond™ Installation Instructions

HSS beams should be grounded with WEEB washer or lug.

Ground the sub-structure to a grounding electrode at the array per NEC regulations and local codes.

With Grounding Lugs:

Grounding rails with approved grounding lugs is necessary per NEC regulations and local code requirements. The rails provide T slots for WEEB grounding lugs from Wiley Electronics. Alternatively, the bottom surface of the rails is available for mounting approved grounding lugs using self-drilling screws. Ground the sub-structure to a grounding electrode at the array per NEC regulations and local codes. Grounding the modules should be done by installing approved grounding lugs on the modules and on the rails and connect these together. The installed equipment grounding is connected to the existing electrical systems according to the NEC code and local regulations.

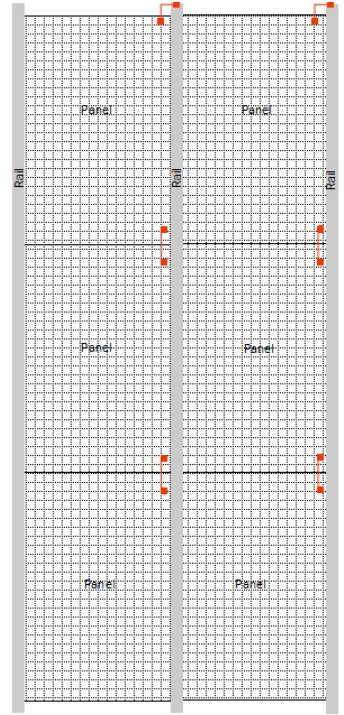

Wire management with the PV Racking System

PV Racking offers advanced wire management that provides a reliable, long lasting solution to the challenges of routing home run wires. The rails include T-slots where the PV Racking Wire Clip and Wire Loop can safely hold wires. Use as many Wire Clips or Wire Loops as necessary. The Wire Rail supports long homerun wiring and provides protection against mechanical damage. Wires can enter and exit the Wire Rail at any point along its length.



This manual provides recommendations. Local and National codes govern the requirements for solar installation and must be followed.



*The Racking System Designed
By Installers for Installers*

General Notes

Installation instruction updates

PV Racking continuously improves the product line. The latest installation information is available at www.PVRacking.com. Contact PV Racking should you have any questions or require additional information (855)787-2257.

PV Racking provides continuous edge support for the modules. PV Racking does not put undo stress on the modules as it is designed to deflect minimally under full load. Design has been analyzed with advanced FEA methods and actual field testing. Please note that it is the installers' responsibility to check with the module manufacturer that this support method is acceptable.

This manual provides recommendations. Local and National codes govern the requirements for solar installation and must be followed.



*The Racking System Designed
By Installers for Installers*

PV Racking 15 year Limited Warranty

PV Racking ("PV Racking") warrants to the original consumer purchaser ("Customer" or "Purchaser") that the PV Racking aluminum frame housing (the "Product") will be free from defects in materials or workmanship as described below under normal installation, application, use and service conditions, for a period of fifteen (15) years from the date of original purchase. If, within the specified warranty period, the Product shall be reasonably proven to be defective, then PV Racking will, at its option, either repair the defect or replace the defective Product or part thereof with a new or remanufactured equivalent at no charge to the Purchaser for parts or labor. PV Racking's total liability hereunder for such repair or replacement shall not exceed the original purchase price of the Product. This Limited Warranty does not cover failure to function caused by damage to the Product while in the Customer's possession, improper installation, unreasonable use or abuse of the Product, failure to provide or use of improper maintenance, failure to follow the written installation and use instructions, cosmetic damage, damage from accident, negligence, misuse, normal wear and tear, or acts of God, and is voided by failure to have the Product installed according to PV Racking's written Installation Manual, by an authorized installer or failure to operate or use the Product in accordance with instructions and warnings contained in the Installation Manual, or if the Product has been modified, repaired or reworked in a manner NOT PREVIOUSLY AUTHORIZED BY PV RACKING IN WRITING. This Limited Warranty does not apply to any foreign residue deposited on the finish. All installations in corrosive atmospheric conditions are excluded. This Limited Warranty does not cover damage to the Product that occurs during its shipment, storage or installation. Manufacturers of related items such as PV modules and flashings may provide written warranties of their own. PV Racking's Limited Warranty covers only its Product, and not any related items. PV Racking makes no warranty against defects in materials and workmanship by component parts from other manufacturers including but not limited to batteries, PV modules, inverters, transformers, disconnects, and data acquisition components. Warranties, if any, for these products may be available through Customer's authorized installer or contractor. This Limited Warranty is voided if the Product is modified, moved or relocated after the original installation.

Neither the sales personnel of PV Racking nor any other person is authorized to make any warranties other than those described herein, or to extend the duration of any warranties beyond the time period described above on behalf of PV Racking.

THE REMEDIES PROVIDED IN THE ABOVE LIMITED WARRANTY ARE THE SOLE AND EXCLUSIVE REMEDIES AVAILABLE TO THE CUSTOMER. NO OTHER EXPRESS WARRANTIES ARE MADE. ALL IMPLIED WARRANTIES, INCLUDING BUT NOT LIMITED TO ANY IMPLIED WARRANTY OF MERCHANTABILITY OR FITNESS FOR A PARTICULAR PURPOSE OR USE, ARE LIMITED IN DURATION AS SET FORTH ABOVE. IN NO EVENT SHALL PV RACKING BE LIABLE FOR ANY INCIDENTAL OR CONSEQUENTIAL DAMAGES, ECONOMIC OR PROPERTY DAMAGE OR PERSONAL INJURIES OR DEATH. SOME STATES DO NOT ALLOW THE EXCLUSION OF INCIDENTAL OR CONSEQUENTIAL DAMAGES OR DAMAGES FOR PERSONAL INJURY OR DEATH. Correction of defects, in the manner and for the period(s) of time described herein, shall constitute complete fulfillment of all liabilities and responsibilities of PV Racking to the Purchaser with respect to the Product and shall constitute full satisfaction of all claims, whether based on contract, negligence, strict liability or otherwise. Some states do not allow limitations on how long an implied warranty lasts or do not allow the exclusion or limitation of incidental or consequential damages, so the above limitations or exclusions may not apply to you. This Limited Warranty gives you specific legal rights and you may also have other rights which vary from state to state.

To obtain warranty services, the Purchaser must contact PV Racking by telephone or mail, and PV Racking will establish and initiate a review of the claim. The Purchaser must maintain proof of purchase of the Product to prove date of purchase in the unlikely event of a claim under this Limited Warranty.

Warranty service contacts:

PV Racking
505 Keystone Road
Southampton, PA 18966
Phone (855)787-2257
Email info@pvracking.com

This manual provides recommendations. Local and National codes govern the requirements for solar installation and must be followed.